

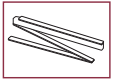

DK Monteringsvejledning

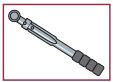

GB Assembly instructions



MOSO® Konsolanker 4,0 / 8,0 kN



DK Sikkerhedsrådgivning

GB Safety advice



Dansk :

Læs denne monteringsvejledning grundigt! Hvis monteringsvejledningen ikke overholdes, bortfalder garantien. Det kan medføre fare og tingsskade.

English:

Please read these assembly instructions carefully! Failure to comply with the assembly instructions will void the guarantee and warranty. It may also result in property damage and significant danger.

DK Oplagring

GB Storage

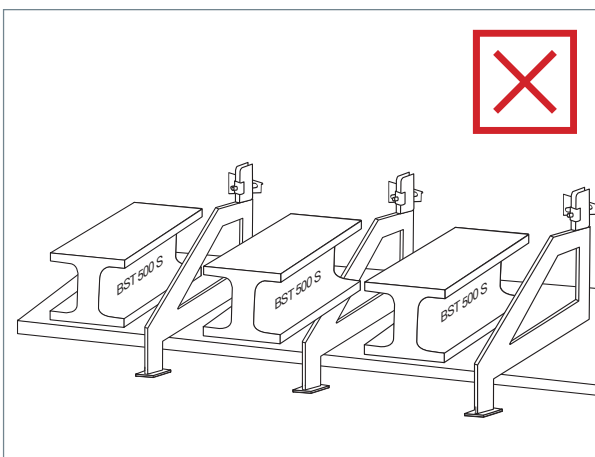
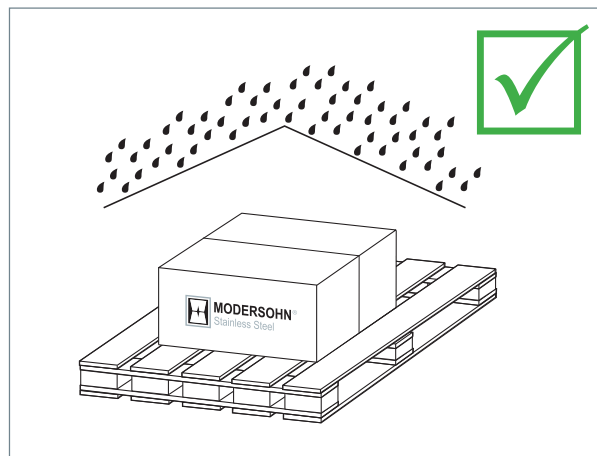
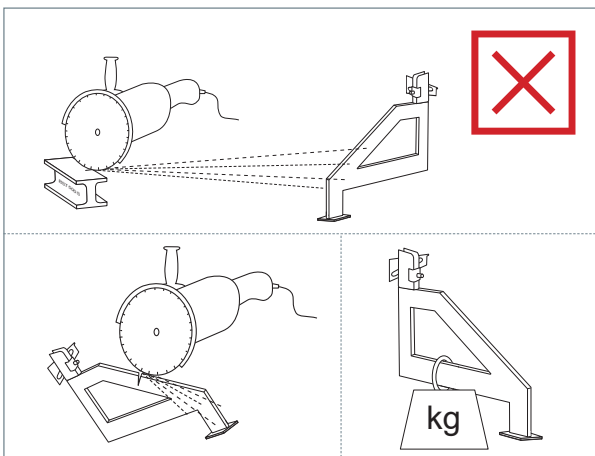

DK Konsollen svarer til eksponeringsklasse MX4 iht. DIN EN 1996-2. Konsoller og fastgørelsesanordninger er dimensioneret af ingeniører.

GB Bracket corresponds to the exposure class MX4 according to DIN EN 1996-2. Bracket and fasteners are designed according to engineering principles.



MOSO® Konsolanker 4,0 / 8,0 kN



1 Monter dyvlerne jævnt før den separate monteringsvejledning. Anbring kilen og bæreankeret på ankerstangen ...

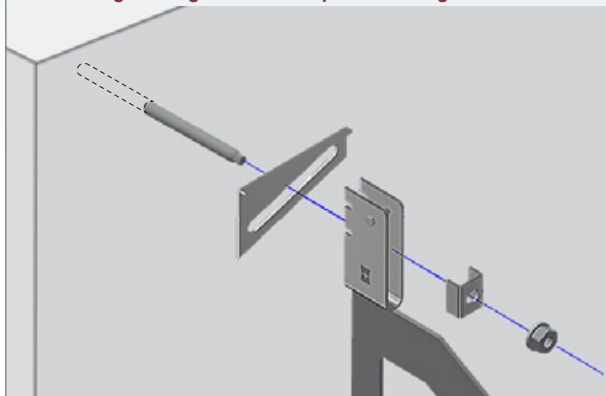

2 ... Sæt den forkrøppede U-skive på, og fastgør den med en møtrik, som spændes med hånden ...

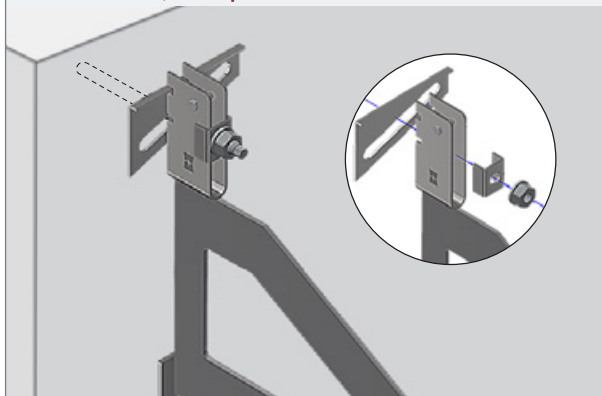

3 ... Juster højden på bæreankeret groft ved at flytte den forkrøppede kileskive, og finjuster den ved at forskyde kileskiven ...

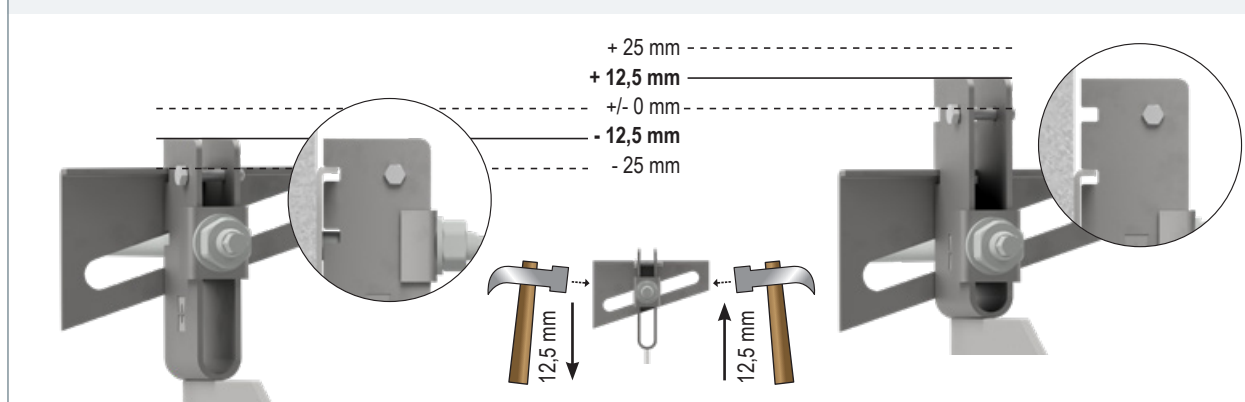

4 ... Anvend tilspændingsmomentet, som fremgår af monteringsvejledningen til dyvlen.

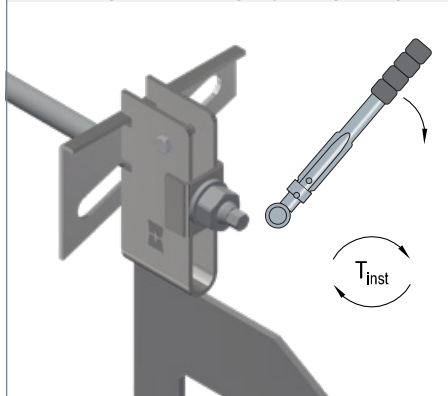

5 Fjern først understøttelsen, når mørtelen er hærdet helt.

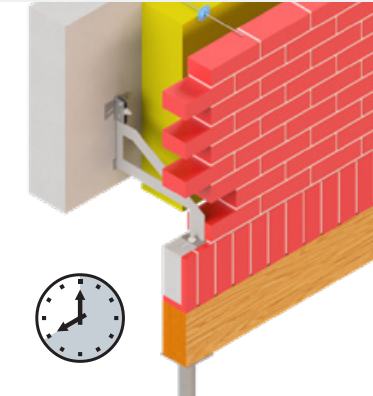

Hvis du har spørgsmål til vores produkter eller har brug for yderligere informationer, står vi naturligvis gerne til rådighed.

If you have any questions regarding our products or require further information, please do not hesitate to contact us.

Du finder yderligere informationer og kontaktpersoner på vores hjemmeside www.jnmurprodukter.dk.

Further information and contacts can also be found on our website: www.jnmurprodukter.dk.

- GB**
- 1** Insert the dowel according to the dowel's assembly instructions. Place the wedge plate and support anchor on the dowel anchor rod.
 - 2** Position the cranked U-washer and pre-assemble it by hand using an SKM hexagon nut.
 - 3** Roughly adjust the height of the support anchor by turning the wedge plate over and finely adjust it by moving the wedge plate.
 - 4** Apply the tightening torque in accordance with the dowel's assembly instructions.
 - 5** Only remove local supports once the masonry mortar has completely hardened!



Facadebefæstelser af murværk